

SPACEWALL[®]
L a d e n b a u s y s t e m

zwei - Warenträger // Accessories



SPACEWALL®

Ladenbausystem

SPACEWALL® Warenträger SPACEWALL® Accessories

Die tragende Rolle im Verkauf

Für verschiedenste Anwendungsbereiche bietet Spacewall® ein umfangreiches Sortiment von Warenträgern aus Metall oder Kunststoff. Die große Auswahl garantiert den optimalen Einsatz von Spacewall® in sämtlichen Branchen des Einzelhandels. Neben der erstklassigen Qualität und Verarbeitung unserer Produkte erreichen wir durch die spezielle Bauweise und Anpassung unserer Warenträger an die Nutprofile eine außergewöhnlich hohe Tragkraft. Profitieren Sie vom „System“ Spacewall durch Einsatz von bestens aufeinander abgestimmten Warenträgern, Abschlussprofilen und Lamellenwänden.

Sonderanfertigungen

Die in diesem Katalog vorgestellten Warenträger stellen unser Standardprogramm dar, dass nahezu alle Bereiche abdeckt. Für spezielle Einsatzzwecke liefern wir jedoch zusätzlich Warenträger und Zubehör nach Ihren Vorgaben. Unsere Berater stehen Ihnen gern zur Seite.

Carrying Your business

For various fields of application, Spacewall® offers a wide range of accessories made of metal or plastic. The great variety guarantees the optimal use of Spacewall® in all retail trade branches. In addition to quality and handling of our products, we achieve a high load capacity of our accessories. Get advantage by using perfectly balanced accessories, profiles and slatwalls.

Custom-made Accessories

The accessories presented herein compose our standard range which covers almost all purposes. For special purposes, we additionally deliver custom-made accessories according to your requirements. We look forward to sharing our expertise with you.





€ 4,99

MZ Pocket Bag
4,99

MZ Snack Jummy
4,99

MEGA ZOO
FOR THREE DAS GROSSTE
€ 4,99

MZ Snack Dummey
4,99

MZ Snack Dummey
4,99

MZ Snack Dummey
4,99

MEGA ZOO
FOR THREE DAS GROSSTE
€ 4,99



2

SPACEWALL®

Ladenbausystem

Warenträger & Zubehör

Accessories

Inhalt

SPACEWALL® Warenträger	6
<i>SPACEWALL accesories</i>	
Metall-Warenträger / Metal Accessories	8
Glas- und Holzbodenträger / Wood and Glas Shelf Brackets ..	8,14
Flachbildschirm-Halter / Flatscreen Holder	8
Sonderprogramm Fahrradteile / Special accessories bike	9
Einzelhaken / Single Hooks	10
Doppelhaken / Double Hooks	11
Pendeltaschen / Price Tags Holders	11
Diebstahlschutz / Theft Protection	11
Abhängearme / Straight and Sloping Arms	12
Abhängestangen / U-racks	15
Sonstige Warenträger / Miscellaneous Accessories	15
Warenträger Seidenmatt / Satin Chromed Accessories	18
Warenträger-Sonderprogramm / Special Accessories	19
Kunststoff-Warenträger / Plastics Accessories	21
Warenträger SLIM / Slim Accessories	28
SPACEWALL® Profile & Kleinteile	31
<i>SPACEWALL Profiles</i>	
SPACEWALL® Interlink	34
<i>SPACEWALL Interlink</i>	
SPACEWALL® Pivot	36
<i>SPACEWALL Pivot</i>	
SPACEWALL® Ladenbausysteme	38
<i>SPACEWALL Shop Systems</i>	
MONOSTYLE / Monostyle	38
MINISTYLE / Ministyle	42
MICROSTYLE / Microstyle	44
ECOSTYLE / Ecostyle	46
Index nach Artikelnummern	50
<i>Index by Item Numbers</i>	



Warenträger direkt Online bestellen unter
www.reinhardt-ladenbau.de



SPACEWALL®

L a d e n b a u s y s t e m

**Metall-
Warenträger**

*Metal
Accessories*

METALL

■ Glas- und Holzbodenträger / Wood and Glas Shelf Brackets

Glasplattenträger Glass Shelf Bracket



mit Gummieinlage,
für Glasplatten mit 8 mm
Stärke und Tiefe bis max. 300 mm
*for glass shelves with 8 mm thickness
and max. depth of 300 mm*

B (mm)	Plattenstärke / Thickness	Art.-Nr.:
50 *	8	MF 265-1
1000	8	MF 265-2
50 *	8	¹⁾ MF 265-7
1000	8	¹⁾ MF 265-8

Glasplattenhalter XL Glass Shelf Bracket XL



für Glasplatten mit 8mm
Stärke und größerer Glas-
plattentiefe von 350 bis 400 mm
*for glass shelves with 8mm thickness
and max. depth of 350 to 400 mm*

B (mm)	Plattenstärke / Thickness	Art.-Nr.:
75 *	8	MF 265-11
1000	8	MF 265-12
75 *	8	¹⁾ MF 265-13
1000	8	¹⁾ MF 265-14

Glasplattenträger Glass Shelf Bracket



wie oben, jedoch für Glas-
platten mit 10 mm Stärke
*see above, but for glass shelves
with 10 mm thickness*

B (mm)	Plattenstärke / Thickness	Art.-Nr.:
50 *	10	MF 265-3
1000	10	MF 265-4
50 *	10	¹⁾ MF 265-9
1000	10	¹⁾ MF 265-10

Holzbodenhalter XL Wood Shelf Bracket XL

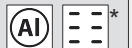

für Holzböden mit 19 mm
Stärke und max. Tiefe
bis 400 mm
*for wood shelves with 19 mm thick-
ness, max. depth up to 400 mm*

B (mm)	Plattenstärke / Thickness	Art.-Nr.:
75 *	19	MF 265-15
1000	19	MF 265-16

¹⁾ eloxiert E6 EV1
/ anodised E6 EV1

■ Flachbildschirm-Halter / Flatscreen Holder

Universal Plasma-Halter Plasma Flatscreen Holder



für Geräte bis 50 Zoll
Bildschirmdiagonale,
Lochgröße: 35 mm,
Lochabstand 18 mm
*for flatscreens up to 50", size of
holes 35 mm, hole spacing 18 mm*

L (mm)	Art.-Nr.:
750	MF 278

Warenträger-Sonderprogramm Fahrradteile / Special Accessories Bike



Halter für Fahrradpedale (3-fach)
Holder for bicycle-pedals (triple)



schwarz pulverbeschichtet
black powder coated

T x B x H (mm)	Art.-Nr.:
240 x 8 x 30	MF 2.80-2

Halter für Anbauteile
Holder for attachment parts

schwarz pulverbeschichtet,
mit 400 mm Querrohr zum
Anbringen von Scheinwerfern, Fahrrad-
computern, KLICKfix-Produkten

black powder coated,
with crosspipe for fixing lighters, bike
computers, KLICKfix products etc.

T x B x H (mm)	Art.-Nr.:
100 x 400 x 30	MF 2.81

Abhängearm (1-kerbig)
Straight Arm (single notch)



schwarz pulverbeschichtet,
zur Präsentation von Rucksäcken,
Kleidungsstücken etc.

black powder coated, for presenting
backpacks, clothing, etc.

T x B x H (mm)	Art.-Nr.:
200 x 6 x 30	MF 2.82

Abhängearm (3-kerbig)
Straight Arm (triple notch)



schwarz pulverbeschichtet,
zur Präsentation von Rucksäcken,
Kleidungsstücken etc.

black powder coated, for presenting
backpacks, clothing, etc.

T x B x H (mm)	Art.-Nr.:
350 x 6 x 30	MF 2.83

Halter für Fahrradpedale (3-fach)
Holder for bicycle-pedals (triple)



schwarz pulverbeschichtet,
mit Gewindebuchsen

black powder coated,
with mounting threads

T x B x H (mm)	Art.-Nr.:
240 x 50 x 30	MF 2.80-1

Hinweis für alle Warenträger in diesem Katalog

Please notice for all accessories in this catalogue

Um die optimale Tragfähigkeit unserer Lamellenwände zu gewährleisten, sollten Spacewall - Warenträger mindestens 10 cm vom Rand der Wand eingesetzt werden.

To ensure the optimum load capacity of our slotwalls, Spacewall accessories should be placed at least 4 inches from the edge of the slotwall.

Einzelhaken / Single Hooks

Einzelhaken Single Hook



Mit Aufkantung 45°
with lip 45°

L (mm)	Art.-Nr.:
40	TW 401-6
60	TW 401-7
80	TW 401-8
100	TW 401-1
150	TW 401-2
200	TW 401-3
250	TW 401-4
300	TW 401-5

Einzelhaken Single Hook

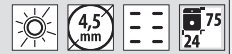

mit Aufkantung 45°
with lip 45°

L (mm)	Art.-Nr.:
100	TW 4100-1
150	TW 4100-2
200	TW 4100-3
250	TW 4100-4
300	TW 4100-5

Einzelhaken mit Kappe Single Hook with cap

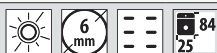

mit Aufkantung 45°,
Kappe schwarz
with lip 45°, black cap

L (mm)	Art.-Nr.:
60	TW 411-1
100	TW 411-2
150	TW 411-3
200	TW 411-4
250	TW 411-5
300	TW 411-6

Schwerlasthaken Single Hook

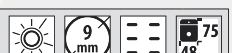

mit Aufkantung
with lip

L (mm)	Art.-Nr.:
160	TW 464

Einzelhaken Single Hook



mit Vorrichtung für Pendel-
tasche TW 476-1 bis 476-3
(separat zu bestellen)

with mounting for price tag
TW 476-1 to 476-3 (order separately)

L (mm)	Art.-Nr.:
150	TW 414-2
200	TW 414-3
250	TW 414-4
300	TW 414-5

Einzelhaken Single Hook

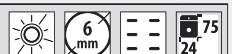

mit 16 mm Scheibe
with disc 16 mm

L (mm)	Art.-Nr.:
150	TW 477-2
200	TW 477-3
250	TW 477-4
300	TW 477-5

Einzelhaken Single Hook



mit Aufkantung 90°
with lip 90°

L (mm)	Art.-Nr.:
50	TW 473-0
100	TW 473-1
150	TW 473-2
200	TW 473-3
250	TW 473-4

Einzelhaken Single Hook

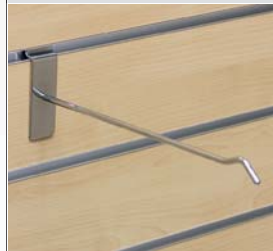

mit Auffangschutz
with drop-down stop

L (mm)	Art.-Nr.:
100	TW 479-1
150	TW 479-2
200	TW 479-3
250	TW 479-4
300	TW 479-5

Doppelhaken / Double Hooks

Doppelhaken
Double Hook

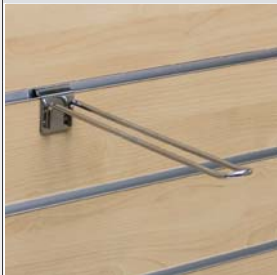

☀️ 5 mm 35 48

L (mm)	Art.-Nr.:
100	TW 400-1
150	TW 400-2
200	TW 400-3
250	TW 400-4
300	TW 400-5

Doppelhaken
Double Hook



☀️ 4,5 mm 42 40

vorne eckig
angular front

L (mm)	Art.-Nr.:
100	TW 4101-1
150	TW 4101-2
200	TW 4101-3
250	TW 4101-4
300	TW 4101-5

Doppelhaken
Double Hook



☀️ 5 mm 35 48

mit Vorrichtung für Pendeltasche TW 476-1 bis 476-3 (separat zu bestellen)
with mounting for price tag TW 476-1 to 476-3 (order separately)

L (mm)	Art.-Nr.:
150	TW 4175-1
200	TW 4175-2
250	TW 4175-3
300	TW 4175-4

Doppelhaken
Double Hook

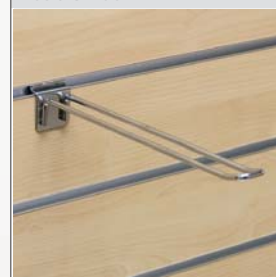

☀️ 5 mm 35 48

eckig
angular

L (mm)	Art.-Nr.:
150	TW 478-2
200	TW 478-3
250	TW 478-4

Pendeltaschen / Price Tags Holders

Pendeltasche
Price Tag Holder

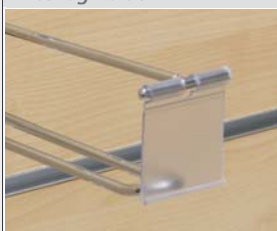

für TW 412 und TW 475
for TW 412 and TW 475

B x H (mm)	Art.-Nr.:
43 x 40	TW 476-1
70 x 40	TW 476-2
100 x 40	TW 476-3

Pendeltasche
Price Tag Holder



für Helm- / Huthalter TW 455-2
for helmet / hat holder TW 455-2

B x H (mm)	Art.-Nr.:
105 x 40	TW 476-5

Diebstahlschutz / Theft Protection

Magnet-Warenschloss
Magnetic Goods Lock



für Einzel- und Doppelhaken bis 6 mm Drahtdurchmesser. Mit Magnet-Spezialschlüssel einfach zu öffnen.
for single and double hooks up to 6 mm wire diameter. Easy to open with special magnetic key.

Farbe / colour	Art.-Nr.:
schwarz / black	TW 499-1
rot / red	TW 499-2
weiß / white	TW 499-3

Schlüssel / key	Art.-Nr.:
	TW 499-0

Diebstahlsicherer Einzelhaken
Theft-proof Single Hook



☀️ 6 mm

zum Sichern von Ware und Einzelhaken, mit Magnet-Spezialschlüssel einfach zu öffnen. Mit Preisschild-Halter. Kunststofffarbe weiß.
to secure goods and single hook, easy to open with magnetic key. With price tag holder. White plastics.

L (mm)	Art.-Nr.:
180	TW 454-1
230	TW 454-2

Schlüssel / key	Art.-Nr.:
	TW 454-0

Abhängearme / Straight and Sloping Arms

Abhängearm
Sloping Arm



30° vorgeneigt,
mit 7 Kugeln
with 7 balls, 30° slant

L (mm)	Rohr / tube (mm)	Art.-Nr.:
400	18 x 18	TW 404

Icons: Sun, 75/48, 75/48

Abhängearm
Sloping Arm



30° vorgeneigt,
mit 7 Kugeln
with 7 balls, 30° slant

L (mm)	Rohr / tube (mm)	Art.-Nr.:
400	38 x 13	TW 405

Icons: Sun, 75/48, 75/48

Abhängearm
Sloping Arm



mit Kugel
with 1 ball

L (mm)	Rohr / tube (mm)	Art.-Nr.:
300	18 x 18	TW 406

Icons: Sun, 75/48, 75/48

Abhängearm
Sloping Arm



30° vorgeneigt,
mit 6 Stiften
with 6 pins, 30° slant

L (mm)	ø Ovalrohr / tube (mm)	Art.-Nr.:
260	30 x 15	TW 441-1

Icons: Sun, 75/48, 75/48

S-Abhängearm
S-Arm



mit 2 Kugeln
with 2 balls

L (mm)	ø Ovalrohr / tube (mm)	Art.-Nr.:
400	30 x 15	TW 442

Icons: Sun, 75/48, 75/48

Z-Abhängearm
Z-Arm

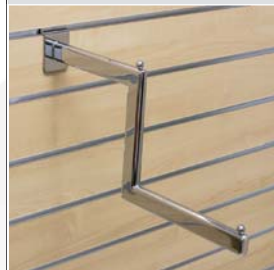

mit 2 Kugeln
with 2 balls

L (mm)	Art.-Nr.:
395	TW 445

Icons: Sun, 75/48, 75/48

Abhängearm
Sloping Arm



30° vorgeneigt,
mit 6 Haken
with 6 hooks, 30° slant

L (mm)	Art.-Nr.:
400	TW 447

Icons: Sun, 75/48, 75/48

Abhängearm
Straight Arm

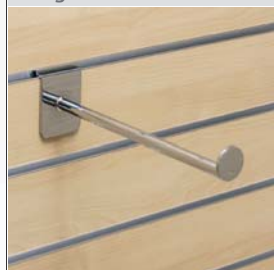

mit Scheibe
with disc

L (mm)	ø Scheibe / disc (mm)	Art.-Nr.:
250	33	TW 448-1
300	33	TW 448-2

Icons: Sun, 12,7mm, 75/48, 75/48

Abhängearm
Sloping Arm



30° vorgeneigt,
mit 10 Kugeln,
gebogen (TW 450)
*with 10 balls, 30° slant,
bent (TW 450)*

L (mm)	ø (mm)	Art.-Nr.:
300	25 x 12,5	TW 450
300	25 x 12,5	TW 450-1

Icons: Sun, 75/48, 75/48

Abhängearm
Straight Arm

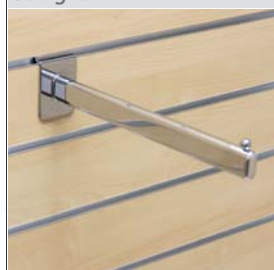

mit Kugel
with ball

L (mm)	ø Ovalrohr / tube (mm)	Art.-Nr.:
300	30 x 15	TW 451-1
400	30 x 15	TW 451-2

Icons: Sun, 75/48, 75/48

Abhängearme / Straight and Sloping Arms



Abhängearm
Bent Arm



vorgeneigt, gebogen
mit 14 Kugeln
slant, with 14 balls

L (mm)	Art.-Nr.:
350	TW 452

Abhängearm
Sloping Arm

30° vorgeneigt,
mit 10 Kerben
with 10 notches, 30° slant

L (mm)	Art.-Nr.:
410	TW 453

Abhängearm
Sloping Arm



15° vorgeneigt
15° slant

L (mm)	Löcher / holes	Art.-Nr.:
430	12	TW 456-1
245	6	TW 456-2

Abhängearm
Straight Arm

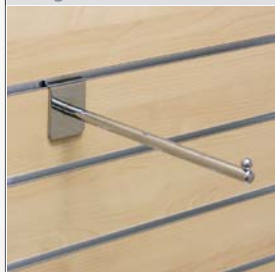
mit Kugel
with ball

L (mm)	Art.-Nr.:
270	TW 463

Abhängearm
Sloping Arm

30° vorgeneigt
30° slant

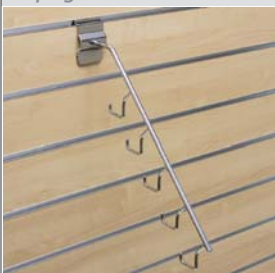
L (mm)	Haken / hooks	Art.-Nr.:
210	3	TW 469-1
300	5	TW 469-2

Abhängearm
Sloping Arm



15° vorgeneigt,
mit 10 Kugeln
with 10 balls, 15° slant

L (mm)	Art.-Nr.:
385	TW 470

Abhängearm
Display

für Ketten, Ringe, Schmuck
mit 50 mm Scheibe
*for chains, rings, jewellery
with 50 mm disc*

L (mm)	Art.-Nr.:
150	TW 481-1
200	TW 481-2

Abhängearm
Display Arm

ausziehbar
telescopic

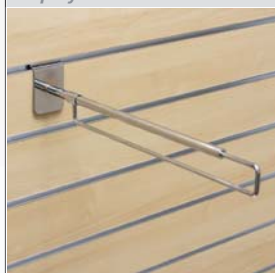
L (mm)	Art.-Nr.:
340 – 680	TW 483

Glas- und Holzbodenträger / Glass and Wood Shelf Brackets

Glas- / Holzbodenträger Glass / Wood Shelf Bracket



(Glas-/Holzbodenauflege
TW 410-1/-2 müssen sep.
bestellt werden)
*(Order Glass / Wood shelf support
clips TW 410-1/-2 separatly)*

L (mm)	Art.-Nr.:
200	TW 402-1
250	TW 402-2
300	TW 402-3

Glas- / Holzbodenträger Glass / Wood Shelf Bracket



max. 40° neigbar
(Glas-/Holzbodenauflege
TW 410-1/-2 müssen separat
bestellt werden)
*adjustable up to 40°
(Order Glass / Wood shelf support
clips TW 410-1/-2 separatly)*

L (mm)	Art.-Nr.:
350	TW 403

Glas- / Holzbodenträger Glass / Wood Shelf Bracket



mit Aufkantung
with lip

T (mm)	Art.-Nr.:
150	TW 409-0
200	TW 409-1
250	TW 409-2
300	TW 409-3
350	TW 409-4

Glas- / Holzbodenauflege Shelf Support Clips

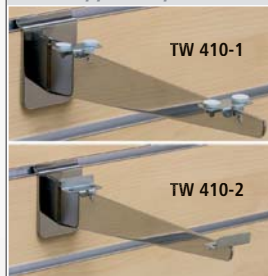

f. Glas- /Holzbodenträger
TW 409-1/2/3/4,
TW 402-1/2/3 und TW 403
*for glass / wood shelf bracket
TW 409-1/2/3/4, TW 402-1/2/3
and TW 403*

L x H (mm)	Boden / shelf	Art.-Nr.:
20 x 38	Glas / glass	TW 410-1
25 x 38	Holz / wood	TW 410-2

Glasbodenträger Glass Shelf Bracket



gerade, inkl. Kunststoff-
ringe
straight, incl. plastic rings

L (mm)	Art.-Nr.:
150	TW 424-0
200	TW 424-1
250	TW 424-2
300	TW 424-3
350	TW 424-4

Regalkonsole Shelf Bracket



für Glas- u. Holzböden,
paarweise
*for glass and wood shelves,
by pairs*

L (mm)	Farbe / colour	Art.-Nr.:
230	weiß / white	TW 430-3
330	weiß / white	TW 430-4
280	weiß / white	TW 430-5

Glas- / Holzbodenträger Glass / Wood Shelf Bracket

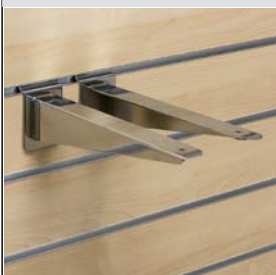

gerade, paarweise
straight, by pairs

L (mm)	Art.-Nr.:
200	TW 443-0
250	TW 443
300	TW 443-1
350	TW 444

Glas- / Holzbodenträger Glass / Wood Shelf Bracket



30° vorgeneigt, paarweise
30° slant, by pairs

L (mm)	Art.-Nr.:
300	TW 443-5

Regalkonsole Shelf Bracket



für Glas- u. Holzböden,
paarweise
for glass and wood shelves, by pairs

L (mm)	Art.-Nr.:
200	TW 4443-0
250	TW 4443-1
300	TW 4443-2
350	TW 4443-3

Glas- / Holzbodenträger Glass / Wood Shelf Bracket

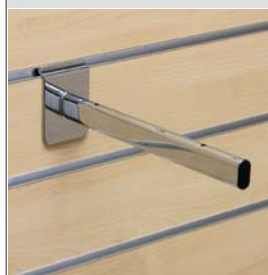

gerade, mit Bohrungen
straight, with bores

L (mm)	ø (mm)	Art.-Nr.:
150	25 x 12,5	TW 472-0
200	25 x 12,5	TW 472-1
250	25 x 12,5	TW 472-2
300	25 x 12,5	TW 472-3
350	25 x 12,5	TW 472-4
400	25 x 12,5	TW 472-5

Abhänggestangen / U-racks

Abhänggestange U-Rack



mit Glasplattenhaltern,
Ovalrohr 25 x 12,5 x 1,5 mm
*with tab end stop, with bores,
size of tube 25 x 12,5 x 1,5*

L x B (mm)	Art.-Nr.:
300 x 640	TW 418

Abhänggestange U-Rack

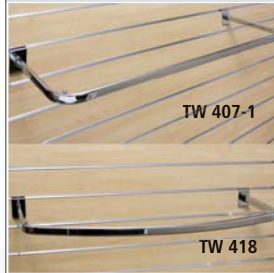

L x B 300 x 1040 mm (inkl.
Platinen), mit 2 Kugeln,
Ovalrohr 25 x 12,5 x 1,5 mm
*300 x 1040 mm (incl. backplates),
with 2 balls, size of tube
25 x 12,5 x 1,5 mm*

Front	Art.-Nr.:
gerade / straight	TW 407-1
gebogen / bent	TW 418

Abhänggestange U-Rack



ohne Glasplattenhalter,
Ovalrohr 25 x 12,5 x 1,5 mm
*without balls or bores
size of tube 25 x 12,5 x 1,5*

L x B (mm)	Art.-Nr.:
300 x 640	TW 407-2

Konsole mit Abhänggestange Shelf with Hanging Tube

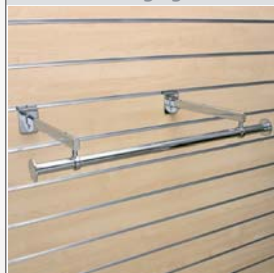

mit je 2 Bohrungen, mit Ring,
Ovalrohr Konsole 25 x 12 mm,
inkl. Abhänggestange gerade 600 mm,
Ø Rohr 22 mm
*with 2 bores apiece, with ring, shelf
tube 25 x 12 mm, incl. hanging tube
straight 600 mm, Ø tube 22 mm*

L x B (mm)	Art.-Nr.:
300 x 600	TW 407-3

Abhänggestange U-Rack



Mit 2 Kugeln,
Ovalrohr 30 x 15 mm,
Platinen außen bündig
*with 2 balls, oval tube 30 x 15 mm,
backplates aligned with tube*

L x B (mm)	Art.-Nr.:
300 x 600	TW 4107-2

Stützzange Upright Bracket



für TW 407 / 407-1 / 407-2 /
418 bei Lamellenabstand
101,8 mm
*for TW 407 / 407-1 / 407-2 / 418
for slatwidth 101,8 mm,*

L (mm)	Art.-Nr.:
278	TW 417

Regalrückplatte Backplate Support



mit 2 Bohrungen
with 2 bores

L x B (mm)	Farbe / colour	Art.-Nr.:
51 x 69	grau / grey*	TW 408
52 x 70	chrom / chrome	TW 474

Sonstige Warenträger Miscellaneous Accessories

Konsole Hidden Shelf



mit 4 Bohrungen
with 4 holes

L x B (mm)	Art.-Nr.:
42 x 48 mm	TW 413

Regal Wire Basket



für CDs, DVDs, Bücher etc.
for CDs, DVDs, books etc.

L x B x H (mm)	Art.-Nr.:
530 x 180 x 180	TW 416

Sonstige Warenträger / Miscellaneous Accessories

Buchhalter Metall Metal Book Holder



silber, für Bücher bis
225 mm Höhe
*silver, for books up to 225 mm
height*

H x B x T (mm)	Art.-Nr.:
170 x 100 x 140	TW 422

Sohlenzeiger Sole Display



L x H (mm)	Art.-Nr.:
200 x 200	TW 423

Helmhalter Helmet Holder



1 Stütze / support
2 Ring / ring

L (mm)	Ø Ring / ring (mm)	Art.-Nr.:
250	150	TW 425

Halter für Basecaps Baseball Cap Holder

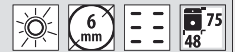

Länge der Form: 195 mm
Length of form: 195 mm

L (mm)	Art.-Nr.:
290	TW 426

Schirmmützen-Präsentier Peaked Cap Holder

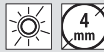

H x B x T (mm)	Art.-Nr.:
175 x 90 x 160	TW 427

Konsole Shelf



silber,
mit 40 mm Abkantung
silver, with 40 mm lip

L x B (mm)	Art.-Nr.:
100 x 250	TW 428

Uhrenhaken Clock Hook



L (mm)	Art.-Nr.:
10	TW 438

Universalhaken Multi-purpose Hook



L x B (mm)	Art.-Nr.:
12 x 26	TW 439

Ringhalterung Ball Display



L (mm)	ø (mm)	Art.-Nr.:
245	145	TW 449
245	110	TW 449-2
245	160*	TW 449-3

* eloxiert / anodized

Helm- / Huthalter Helmet / Hat Holder



mit Scheibe
with disc

L (mm)	ø Scheibe / disc (mm)	Art.-Nr.:
200	78	TW 455

Sonstige Warenträger / Miscellaneous Accessories

Helm- / Huthalter Helmet / Hat Holder



schwarz, mit Vorrichtung für Preisschildhalter TW 476-5 (separat zu bestellen)
black, with mounting for price tag TW 476-5 (order separatly)

L x B x H (mm)	Art.-Nr.:
280 x 65 x 150	TW 455-2

Warenausschütze Wire Basket



TW 458: vorgeneigt
TW 459: gerade
TW 458: slant
TW 459: straight

L x B x H (mm) Art.-Nr.:	
610 x 305 x 75	TW 458
570 x 300 x 85	TW 459

Warenkorb Wire Basket

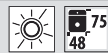

L x B x H (mm) Art.-Nr.:	
300 x 150 x 150	TW 460-1
300 x 300 x 200	TW 460-2

Regal Wire Shelf



L x B 600 x 300 mm
size 600 x 300 mm

Neigung / slant	Art.-Nr.:
30° mit Aufkantung / 30° with lip	TW 461-1
gerade mit Aufkantung / straight with lip	TW 461-2

Bilderhaken Picture Hook



L x B (mm)	Art.-Nr.:
14 x 26	TW 462-1
14 x 52	TW 462-2

Haken Hook

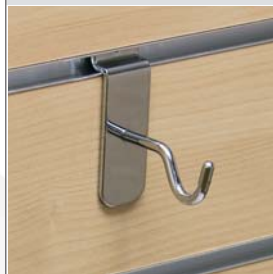

L (mm)	Art.-Nr.:
55	TW 465

Drehkranz Jewellery Star

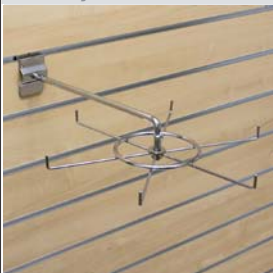

L (mm)	Art.-Nr.:
460	TW 471

Kleiderbügel Display Hanger

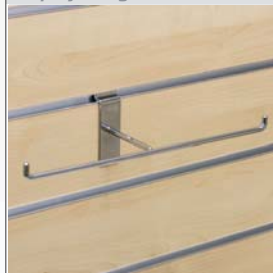
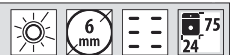

L (mm)	Art.-Nr.:
295	TW 480

Frontalbügel Cravat Holder



L (mm)	Art.-Nr.:
600	TW 482

Kleiderbügel Display Hanger

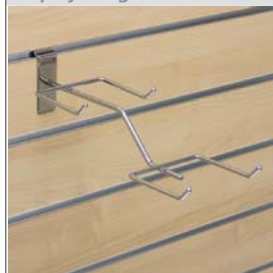

für Gürtel
for belts

L (mm)	Art.-Nr.:
300	TW 484

Warenträger Seidenmatt / Satin Chromed Accessories

Doppelhaken Double Hook



L (mm)	Art.-Nr.:
100	TW 500-1
150	TW 500-2
200	TW 500-3
250	TW 500-4

Einzelhaken Single Hook



Mit Aufkantung 45°
with lip 45°

L (mm)	Art.-Nr.:
100	TW 501-1
150	TW 501-2
200	TW 501-3
250	TW 501-4

Abhängearm Sloping Arm



30° vorgeneigt,
mit 7 Kugeln
with 7 balls, 30° slant

L (mm)	Rohr / tube (mm)	Art.-Nr.:
400	18 x 18	TW 504

Abhängearm Straight Arm



gerade, mit Kugel
with 1 ball

L (mm)	Rohr / tube (mm)	Art.-Nr.:
300	18 x 18	TW 506

Abhängestange U-Rack



Ovalrohr 25 x 12,5 mm,
außen geschweißt,
mit 2 Kugeln
oval tube 25 x 12,5 mm,
outward welded, with 2 balls

L x B (mm)	Art.-Nr.:
300 x 600	TW 507-2

Glas- / Holzbodenkonsole Glass / Wood Shelf Bracket

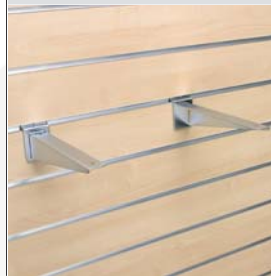

gerade, paarweise
straight, by pairs

L (mm)	Art.-Nr.:
250	TW 543
300	TW 543-1

Abhängearm Straight Arm

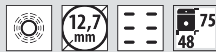
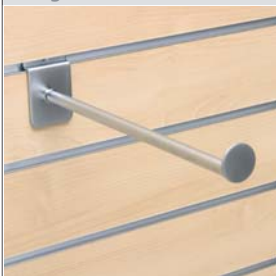

mit Scheibe
with disc

L (mm)	ø Scheibe / disc (mm)	Art.-Nr.:
300	33	TW 548-2

Abhängearm Sloping Arm



30° vorgeneigt,
mit 10 Kugeln
with 10 balls, 30° slant

L (mm)	ø (mm)	Art.-Nr.:
300	25 x 12,5	TW 550-1

Abhängearm Straight Arm



gerade, mit Kugel
with ball

L (mm)	ø Ovalrohr / tube (mm)	Art.-Nr.:
300	30 x 15	TW 551-1

Einzelhaken Single Hook



mit 16 mm Scheibe
with disc 16 mm

L (mm)	Art.-Nr.:
300	TW 577-5



SPACEWALL®
Ladenbausystem

SONDERPROGRAMM G

Sonderprogramm G
Special Accessories G

Warenträger-Sonderprogramm G / Special Accessories G



Doppelhaken
Double Hook

Packungsinhalt: 25 Stück
25 pieces packing

L (mm)	Art.-Nr.:
120	G 101
200	G 102
250	G 103



Einzelhaken
Single Hook

Packungsinhalt: 25 Stück
25 pieces packing

L (mm)	Art.-Nr.:
120	G 104
200	G 105
250	G 106

Doppelhaken
Double Hook

Packungsinhalt: 25 Stück
25 pieces packing

L (mm)	Art.-Nr.:
120	G 107
200	G 108
250	G 109



Einzelhaken
Single Hook



Packungsinhalt: 25 Stück
25 pieces packing

L (mm)	Art.-Nr.:
120	G 110
200	G 111
250	G 112

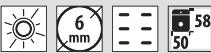

Kurzer Abhängehaken
Short Hook

Packungsinhalt: 25 Stück
25 pieces packing

L (mm)	Art.-Nr.:
45	G 113

Schwerlasthaken
Heavy Duty Hook

Packungsinhalt: 25 Stück
25 pieces packing

L (mm)	Art.-Nr.:
350	G 122

SPACEWALL®
Ladenbausystem



Kunststoff - Warenträger
Plastics Accessories

KUNSTSTOFF

Konsole Shelf



für Schuh- u. Hartwaren
for shoes and homewares

T x B (mm)	Art.-Nr.:
155 x 300	PF 101-0
100 x 250	PF 101-1
250 x 300 mit Stützen	PF 101-2 *
102 x 202	PF 101-4
155 x 255	PF 101-5
100 x 250 Styren / styrene	PF 101-6

* handgefertigt / handmade



Schuhregal Shoe Shelf



25° vorgeneigt,
mit Spitzenstütze
25° slant, with toe stop

T x B (mm)	Art.-Nr.:
290 x 100	PF 102
290 x 200	PF 103



Schuhregal Shoe Shelf



25° vorgeneigt,
mit 5 mm Absatzstütze
25° slant, with 5 mm heel stop

T x B (mm)	Art.-Nr.:
285 x 200	PF 105



Schuhregal Shoe Shelf



35° vorgeneigt, mit Spitzen-
stütze, Materialstärke
Einhängung 6 mm
*35° slant, with toe stop, material
thickness of suspension 6 mm*

T x B (mm)	Art.-Nr.:
linksseitig / left 100 x 300	PF 106
rechtsseitig / right 100 x 300	PF 107



Regal Shelf



mit 2 cm Aufkantung
with 2 cm lip

T x B (mm)	Art.-Nr.:
110 x 250	PF 110
200 x 250	PF 111



Schaukasten Display



für Hemden, Blusen,
T-Shirts, Pullover, Strick-
waren etc.
*for shirts, blouses, T-shirts, sweaters,
knitwear etc.*

T x B x H (mm)	Art.-Nr.:
305 x 278 x 270	PF 112-1



Schauregal Shelf

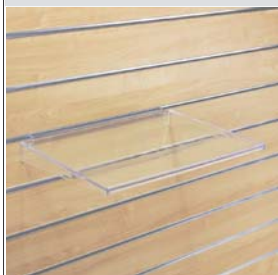

T x B (mm)	Art.-Nr.:
5 mm Aufkantung / 5 mm lip	PF 113-1
280 x 400	PF 113-2
ohne Aufkantung / without lip	PF 113-3
240 x 400	
7,5 mm Aufkantung, Styren 7,5 mm lip, styrene	
270 x 400	



Schaukasten Display



für Handschuhe, Schals,
Kleinartikel, etc.
for gloves, scarfs, small items etc.

T x B x H (mm)	Art.-Nr.:
150 x 300 x 35	PF 114-1
150 x 150 x 35	PF 114-2



Trennkreuz Separating Cross



T x B (mm)	Art.-Nr.:
für PF 114-1 / for PF 114-1	PF 114-3
150 x 300 x 35	
für PF 114-2 / for PF 114-2	PF 114-4
150 x 150 x 35	



Grußkartenrinne Card Rack



ohne Seitenabschluß,
auch für DVDS, Bücher, etc.,
mit Aufkantung 45 mm,
Neigung ca. 30°
*without side parts, with 45 mm lip,
slant ca. 30°*

T x B (mm)	Art.-Nr.:
55 x 600	PF 115



Prospekthalter A4 / A5

Leaflet Holder A4 / A5



für Karten, Bücher,
Zeitschriften etc.
for cards, books, journals etc.

T x B x H (mm)	Art.-Nr.:
40 x 160 x 220 (DIN A5)	PF 117-0
40 x 220 x 225 (DIN A4)	PF 117-1

Prospekthalter A4 / DIN lang

Leaflet Holder A4 / DIN lang

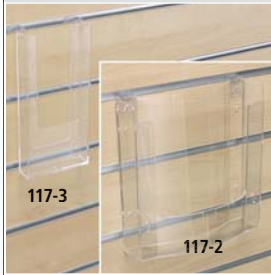

für Karten, Bücher,
Zeitschriften etc.
for cards, books, journals etc.

T x B x H (mm)	Art.-Nr.:
65 x 225 x 225 (DIN A4)	PF 117-2
20 x 110 x 200 (DIN lang)	PF 117-3

Prospekthalter A4

Leaflet Holder A4



mit Phototasche
with photo pocket

T x B x H (mm)	Art.-Nr.:
85 x 220 x 305	PF 118

Preisschildhalter

Price Tag Holder



B x H (mm)	Art.-Nr.:
100 x 55	PF 120-1

Konsole

Shelf



mit Einschub für Produkt-
bzw. Preisinformationen,
für Schuhe, Hartwaren etc.
*with price tag holder, for shoes,
homewares etc.*

T x B (mm)	Einschub- höhe(mm)*	Art.-Nr.:
100 x 203	30	PF 121-0
100 x 250	50	PF 121-1
100 x 230	30	PF 121-2
100 x 229	32	PF 121-4
100 x 250	38	PF 121-5

* size of price holder

Schuhhalter

Shoe Swivel Bracket



drehbar, mit Spitzenstütze
*swivel-mounted,
with toe tip*

T x B (mm)	Art.-Nr.:
230 x 70	PF 122

Schaukasten

Angled Display

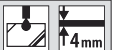

vorgeneigt, für Prospekte,
Schuhe, Zeitschriften etc.
*slanted, for brochures, shoes,
journals etc.*

T x B (mm)	Art.-Nr.:
350 x 230 (DIN A4)	PF 124

Haken

Hook



B x H (mm)	Art.-Nr.:
25 x 60	PF 141

Kartenhalter

Holder for Posters



für Plakate, Karten,
Poster etc.
for bills, cards, posters etc.

B x H (mm)	Art.-Nr.:
25 x 70	PF 142

Display
Display



30° vorgeneigt
für Bücher, Prospekte, etc.
30° slant, for books, brochures etc.

T x B x H (mm)	Aufkantung / lip (mm)	Art.-Nr.:
310x220x60	100	PF 145



Buchhalter
Angled Book Holder



vorgeneigt
slant

T x B x H (mm)	Aufkantung / lip (mm)	Art.-Nr.:
155x100x100	15	PF 146



Hemdenpräsentier
Shirt Display



40° vorgeneigt
40° slant

T x B (mm)	Art.-Nr.:
300 x 200	PF 149



Damenbein
Ladies Leg



gestreckt,
inkl. Ring-Halterung
straight, incl. holder ring

L (mm)	Art.-Nr.:
700	PF 155



Warenkasten
Box



vorne geschlossen,
ideal für Feinstrümpfe,
Taschentücher etc.
closed front, ideal for stockings,
handkerchiefs etc.

T x B x H (mm)	Art.-Nr.:
178 x 190 x 245	PF 157



Präsentier
Display



T x B x H (mm)	Art.-Nr.:
255 x 305 x 150	PF 158



Universalmulde
Multi-purpose Display



für Bücher, Zeitschriften,
DVDs, Postkarten, etc.
for books, journals, DVDs, cards etc.

T x B x H (mm)	Aufkantung / lip (mm)	Art.-Nr.:
88x220x130	80	PF 159



Einzelhaken
Single Hook



L (mm)	Farbe / colour	Art.-Nr.:
100	schwarz / black	PF 161-1
100	weiß / white	PF 161-2
100	grau / grey	PF 161-3
100	farblos / transparent	PF 161-4



Einzelhaken
Single Hook



L (mm)	Farbe / colour	Art.-Nr.:
150	schwarz / black	PF 162-1
150	weiß / white	PF 162-2
150	grau / grey	PF 162-3
150	farblos / transparent	PF 162-4



Universalhaken
Multi-purpose Hook



vielseitig einsetzbar, mit
festem Sitz in der Schiene
snug fit in slat

B x H (mm)	Art.-Nr.:
20 x 21	PF 166



Universalköcher

Quiver



mit 11 Röhren,
für Pinsel, Stifte etc.
*with 11 tubes, for brushes, pencils
etc.*

T x B (mm)	Art.-Nr.:
155 x 205	PF 167

CD-Halter

CD-Display



B (mm)	Art.-Nr.:
150 (5 CDs)	PF 168-1
295 (10 CDs)	PF 168-2

Bilderrahmenhalter

Picture Frame Holder



T (mm)	Art.-Nr.:
290 Links / left	PF 176-2
290 Rechts / right	PF 176-3

Brillenhalter

Glasses Holder



für eine offene Präsentation
for opened presentation

L (mm)	Art.-Nr.:
165	PF 181-1

Brillenhalter

Glasses Holder



für eine geschlossene
Präsentation
for closed presentation

L (mm)	Art.-Nr.:
45	PF 181-2

Armbanduhrenhalter

Holder for Watches



T x H (mm)	Art.-Nr.:
50 x 80	PF 184

Display

Display



Halterung für Ohringe und
Schmuck
Holder for earrings and jewellery

T x B x H (mm)	Art.-Nr.:
260 x 600 x 300	PF 185

Display

Display



Präsentier für Kleinteile
Display for small items

T x B x H (mm)	Art.-Nr.:
100 x 350 x 130	PF 186

Schmuckpräsentier

Jewellery Display



Halterung für Uhren und
Armreifen, eine Röhre
Holder for watches, one tube

T x B (mm)	Art.-Nr.:
100 x 335	PF 195

Schmuckpräsentier

Jewellery Display



Halterung für Uhren und
Armreifen, zwei Röhren
Holder for watches, two tubes

T x B (mm)	Art.-Nr.:
100 x 340	PF 196

Schmuckpräsentier
Jewellery Display



Halterung für Fingerringe
Holder for rings

T x B (mm) Art.-Nr.:
100 x 350 PF 197

Schmuckpräsentier
Jewellery Display



Präsentier für Halsketten
Holder for Necklaces

T x B (mm) Art.-Nr.:
100 x 350 PF 198

Präsentier für Zeitschriften
Holder for Newspapers



vorgeneigt,
mit Aufkantung 30 mm
slant, with 30 mm lip

T x B (mm) Art.-Nr.:
260 x 600 PF 199

Präsentier für Zeitschriften
Holder for Newspapers

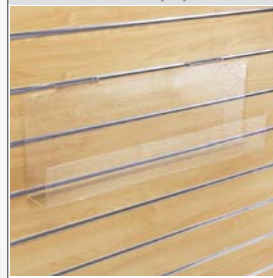

mit Aufkantung 80 mm
with 80 mm lip

T x B (mm) Art.-Nr.:
70 x 600 x 200 PF 200

Prospekthalter
Leaflet Holder



für Format DIN A4 / A5
for DIN A4 / A5 leaflets

T x B x H (mm) Art.-Nr.:
40 x 165 x 155 (DIN A5) TW 485-1
40 x 220 x 270 (DIN A4) TW 485-2

Plakathalter
Poster Holder



für Format DIN A4
for DIN A4 leaflets

L x B (mm) Art.-Nr.:
216 x 320 TW 486

Display
Display



30° vorgeneigt,
mit Aufkantung
30° slant, with front lip

L x B x H (mm) Art.-Nr.:
285 x 220 x 33 TW 487

Konsole
Shelf

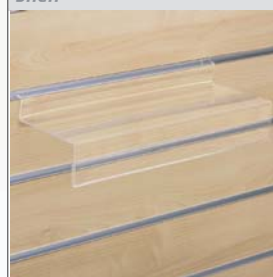

Mit Einschub für Preis-
bzw. Produktinformation
(Einschubhöhe 42 mm)
with sign holder (height 42 mm)

L x B x H (mm) Art.-Nr.:
100 x 250 x 44 TW 488
105 x 300 x 44 TW 488-1

Smartphone-Halter
Smart Phone Holder



für nahezu alle aktuellen
Smartphone-Modelle bis
67 mm Breite und 20 mm Tiefe
for almost all current smart phone
models up to 67 mm width and 20
mm thickness.

T x B x H (mm) Art.-Nr.:
73 x 73 x 124 TW 489-1

Smartphone-Halter XL
Smart Phone Holder XL



für nahezu alle aktuellen
Smartphone-Modelle bis
88 mm Breite und 20 mm Tiefe
for almost all current smart phone
models up to 88 mm width and 20
mm thickness.

T x B x H (mm) Art.-Nr.:
90 x 80 x 160 TW 489-3

iPad-Halter

iPad Holder



für die iPad-Modelle 2 und 3
(sowie vergleichbare Tablets
bis 250 x 186 x 15 mm)

for iPad models 2 and 3
(resp. similar tablets up to
250 x 186 x 15 mm)

T x B x H (mm)	Art.-Nr.:
84 x 194 x 258	TW 489-2

Schaukasten

Display



L x H x B (mm)	Art.-Nr.:
100 x 290 x 50	TW 491

Prospekthalter DIN A4

Leaflet Holder DIN A4



T x B x H (mm)	Art.-Nr.:
43 x 224 x 233,5	TW 493

Preisschildhalter

Price Tag Holder



B x H (mm)	Art.-Nr.:
100 x 50	TW 494

Buchhalter

Book Display



vorgeneigt
slanted

T x B x H (mm)	Art.-Nr.:
90 x 100 x 124	TW 495

Prospekthalter DIN A4

Leaflet Holder DIN A4



T x B x H (mm)	Art.-Nr.:
67 x 226 x 268	TW 496

Konsole

Shelf



T x B x H (mm)	Thickn. (mm)	Art.-Nr.:
115 x 250 x 50	2,5	TW 497-1
115 x 290 x 50	3	TW 497-2

Konsole

Shelf



T x B (mm)	Thickn. (mm)	Art.-Nr.:
155 x 300	3	TW 498-1
115 x 250	2,5	TW 498-2

Acryldisplay

Display



B x H 230 x 289 mm
size 230 x 289 mm

Öffnung / opening	Art.-Nr.:
rechts / right	TW 191 R
links / left	TW 191 L

SPACEWALL®

Ladenbausystem

SLIMS

Warenträger SLIM
Slim Accessories

Glasplattenträger

Glass Shelf Bracket



für 8 mm Glasböden
for 8 mm glass shelves

B (mm)	Art.-Nr.:
50	SF 714-1
1000	SF 714-2

auf Anfrage auch eloxiert lieferbar
/ anodized on request

Doppelhaken

Double Hook



L (mm)	Art.-Nr.:
100	SF 715-1
150	SF 715-2
200	SF 715-3
250	SF 715-4

Einzelhaken

Single Hook



L (mm)	Art.-Nr.:
60	SF 716-1
100	SF 716-2
150	SF 716-3
200	SF 716-4
250	SF 716-5

Abhängearm

Straight Arm



mit 12 mm hohem Stift
with 12 mm pin

L (mm)	Pin Ø	Art.-Nr.:
100	7 mm	SF 720-1
230	7 mm	SF 720-2
350	7 mm	SF 720-3

Halter für Abhängestange

Bracket for Hanging Tube



mit Ring für Abhängestange
SF 722-1 oder -2
with bearing for hanging tube
SF 722-1 or -2

L (mm)	Art.-Nr.:
300	SF 721

Abhängestange

Hanging Tube



für Halter SF 721
for bracket SF 721

L (mm)	Pin Ø	Art.-Nr.:
620	7 mm	SF 722-1
1000	7 mm	SF 722-2

Regalrückplatte

Back Plate Support



mit vier Bohrungen
with 4 holes

L x B (mm)	Art.-Nr.:
66 x 48	SF 723

Abhängearm

Sloping Arm

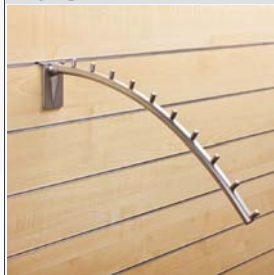

mit 10 Stiften (Abstand 35 mm)
with 10 pins (interval 35 mm)

L (mm)	Pin Ø	Art.-Nr.:
390	7 mm	SF 726

Glas- / Holzbodenträger

Glass / Wood Shelf bracket



mit 2 Bohrungen
with 2 holes

L (mm)	Art.-Nr.:
200	SF 730-1
300	SF 730-2

Abhängearm



Sloping Arm



mit 10 Stiften
with 10 pins

L (mm)	Art.-Nr.:
350	SF 731



Abhängearm
Straight Arm

gerade, mit Stift
with pin



L (mm)	Pin Ø	Art.-Nr.:
100	7 mm	SF 732-1
150	7 mm	SF 732-2
200	7 mm	SF 732-3
250	7 mm	SF 732-4

Doppelhaken
Double Hook

L (mm)	Art.-Nr.:
100	SF 733-1
150	SF 733-2
200	SF 733-3
250	SF 733-4



Abhängearm
Straight Arm

mit Aufkantung 20°
with lip 20°



L (mm)	Art.-Nr.:
100	SF 734-1
150	SF 734-2
200	SF 734-3
250	SF 734-4

Prospekthalter
Leaflet Holder



T x B x H (mm)	Art.-Nr.:
40 x 165 x 155 (DIN A5)	SF 717-1
40 x 220 x 270 (DIN A4)	SF 717-2

Konsole
Shelf

T x B (mm)	Art.-Nr.:
155 x 300	SF 718

Schaukasten
Display

T x B x H (mm)	Art.-Nr.:
150 x 300 x 35	SF 741
150 x 150 x 35	SF 742

Display
Display







30° vorgeneigt
30° slant

T x B x H (mm)	Aufkantung / lip (mm)	Art.-Nr.:
310 x 220 x 60	100	SF 745



Buchhalter
Angled Book Holder

vorgeneigt
slant



T x B x H (mm)	Aufkantung / lip (mm)	Art.-Nr.:
155 x 100 x 100	15	SF 746

Präsentier
Display

T x B x H (mm)	Art.-Nr.:
255 x 305 x 150	SF 758

Universalmulde
Multi-purpose Display

T x B x H (mm)	Aufkantung / lip (mm)	Art.-Nr.:
88 x 220 x 130	80	SF 759



SPACEWALL®
Ladenbausystem

Profile & Kleinteile
Profiles & Small Components

PROFILLE

Alu- Kantenschutz
Alu Edge Cover



Abschlussleiste,
20 x 22,8 x 5,3 mm

L (mm)	Ausführung / Style	Art.-Nr.:
2500	blank/raw	KP 302
3000	blank/raw	KP 302-0
2500	eloxiert E 6 EV1 / anodized E 6 EV1	KP 302-1
3000	eloxiert E 6 EV1 / anodized E 6 EV1	KP 302-2

Alu- Abdeckprofil
Alu Edge Cover



40 x 6 x 1,3 mm

L (mm)	Ausführung / Style	Art.-Nr.:
2500	blank/raw	KP 320
3000	blank/raw	KP 320-0
2500	eloxiert E 6 EV1 / anodized E 6 EV1	KP 320-1
3000	eloxiert E 6 EV1 / anodized E 6 EV1	KP 320-2

Alu - Stosskantenverbinder
Alu Buttjoint Connection



zum Verbinden von
Stoßkanten, 18 x 7 x 0,85 mm

L (mm)	Ausführung / Style	Art.-Nr.:
2500	blank/raw	KP 303
3000	blank/raw	KP 303-0
2500	eloxiert E 6 EV1 / anodized E 6 EV1	KP 303-1
3000	eloxiert E 6 EV1 / anodized E 6 EV1	KP 303-2

Alu - Eckverbinder
Alu Corner Connection



zum Verbinden von
90°-Ecken, 47,5 x 47,5 mm

L (mm)	Ausführung / Style	Art.-Nr.:
2500	blank/raw	KP 301
3000	blank/raw	KP 301-0
2500	eloxiert E 6 EV1 / anodized E 6 EV1	KP 301-1
3000	eloxiert E 6 EV1 / anodized E 6 EV1	KP 301-2

Alu - Abschlussprofil
Alu Edge Cover



47,5 x 22 mm

L (mm)	Ausführung / Style	Art.-Nr.:
2500	blank/raw	KP 314
3000	blank/raw	KP 314-0
2500	eloxiert E 6 EV1 / anodized E 6 EV1	KP 314-1
3000	eloxiert E 6 EV1 / anodized E 6 EV1	KP 314-2

Lackierte oder pulverbeschichtete Profile in jeder Sonderfarbe (z.B. gemäß RAL) auf Wunsch erhältlich.

Coated or powder-coated profiles in any custom color (e.g. according to RAL) available on request.

Alu- Einhängprofil waagrecht
Alu Split Batten horizontal



für die Wandmontage
von Paneelen, paarweise,
Höhe 28 mm
*for wall mounting of panels,
by pairs, height 28 mm*

L (mm)	Art.-Nr.:
2400	KP 305

Montage-Profil senkrecht
Vertical Mounting Profile



Zur einfachen, schnellen und exakten Montage von Lamellenwänden. (Passgenaue CNC-Bohrungen für die Schrauben werden von Spacewall vorgefertigt.)

L (mm)	Art.-Nr.:
2439	KP 330-1

Bohrschablone
Drill Stencil



Montagehilfe für die Durchgangsbohrungen in den Aluprofilen
Nur für SPACEWALL® light
*Mounting guide for through-hole drilling of alu-profiles.
For SPACEWALL® light only.*

Art.-Nr.:
KP 310

Führungshilfen
Guide Discs

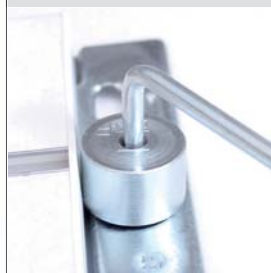

für KP 330-1, zum passgenauen Einhängen der Lamellenwände, 6 Stück
for use with KP 330-1, for precise suspension of slat walls, 6 pieces

Ø (mm)	Art.-Nr.:
27	KP 331

Bit mit Abstandhalter

Distance guide socket Bit



für KP 330-1
for KP 330-1

Art.-Nr.:
KP 332

Gummiringe

Plastic Ring

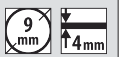

klar, für Glasbodenträger TW 424
clear, for glass shelf bracket
TW 424

Art.-Nr.:
KP 316

Glassauger

Glass-Buffer



verwendbar für Artikel:
for use in combination with:
TW 430, TW 443, TW 444,
TW 4443, TW 472, TW 543

Ø (mm)	Art.-Nr.:
15	KP 315-1
10	KP 315-2

Elastikpuffer

Elastic Buffer

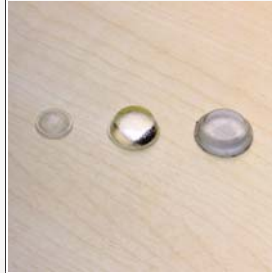

selbstklebend, glasklar
ideal als Kratzschutz und
Abstandhalter
self adhesive, clear

H (mm)	Ø (mm)	Art.-Nr.:
2,2	7,9	KP 308-1
3,5	12,7	KP 308-2
5,0	11,1	KP 308-3



SPACEWALL®
Ladenbausystem

INTERLINK

INTERLINK
Interlink

Interlink Profile

Interlink Profiles



Elektrifizierte Power-Profile
inkl. Trafo (24 V / 60 Watt),
nach Vorgabe vormontiert

*Power profiles with electrical
mounting, incl. AC-adaptor (24V /
60 W), comes pre-mounted according
specifications*

L (mm)	Stk./pcs.	Art.-Nr.:
1000	1	IL 900-1
1000	5	IL 900-2
1200	1	IL 900-3
1200	4	IL 900-4

Interlink Glasplattenhalter

Interlink Glass Shelf Bracket



Aluminium-Glasplattenhalter mit
integrierten Kontakten,
für IL 902-2 Glasplatte

*aluminium glass shelf bracket with
internal power connection, for use
with IL 902-2 glass shelf*

L (mm)	Art.-Nr.:
980	IL 902-1

Interlink Glasplattenhalter weiß

Interlink Glass Shelf white



Aluminium-Glasplattenhalter für
8 mm Glasplatten, inkl. LED-Leiste
weiß, ohne Glasplatte (andere Farben
außer weiß, rot, blau auf Anfrage).

*aluminium glass shelf bracket for
8 mm glass shelves, incl. LED bar white,
without glass shelf (other colours than
white, red, blue inquire directly).*

L (mm)	Art.-Nr.:
490	IL 901-1
590	IL 901-2
980	IL 901-3
1180	IL 901-4

Interlink Holzfachboden

Interlink Wooden Shelf



Holzfachboden mit versenkter,
nach unten gerichteter LED-Leiste, inkl.
Fachbodenträger mit Kontakten

*Wooden shelf with flush-mounted,
downward-facing LED bar, incl. shelf
brackets with power connection*

L x T x H (mm)	Art.-Nr.:
1010 x 400 x 19	IL 903

Interlink Glasplattenhalter rot

Interlink Glass Shelf red

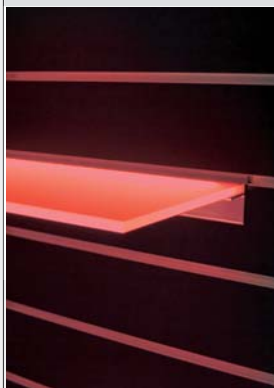

Aluminium-Glasplattenhalter für
8 mm Glasplatten, inkl. LED-Leiste
rot, ohne Glasplatte (andere Farben
außer weiß, rot, blau auf Anfrage).

*aluminium glass shelf bracket for
8 mm glass shelves, incl. LED bar red,
without glass shelf (other colours than
white, red, blue inquire directly).*

L (mm)	Art.-Nr.:
490	IL 901-9
590	IL 901-10
980	IL 901-11
1180	IL 901-12

Interlink Glasplattenhalter blau

Interlink Glass Shelf blue



Aluminium-Glasplattenhalter für
8 mm Glasplatten, inkl. LED-Leiste
blau, ohne Glasplatte (andere Farben
außer weiß, rot, blau auf Anfrage).

*aluminium glass shelf bracket for
8 mm glass shelves, incl. LED bar blue,
without glass shelf (other colours than
white, red, blue inquire directly).*

L (mm)	Art.-Nr.:
490	IL 901-5
590	IL 901-6
980	IL 901-7
1180	IL 901-8

SPACEWALL®
Ladenbausystem

PIVOT

Pivot
Pivot

Pivot Säule
Pivot Tube



Aluminium silber eloxiert, inkl. Abschlussprofil KP 314-1
Aluminium silver anodised, incl. edge cover KP 314-1

H (mm)	H panel (mm)	Art.-Nr.:
2520	2430	MI 501
2090	2000	MI 502
1590	1500	MI 503

Pivot Abschluss-Säule
Pivot End Tube



Aluminium silber eloxiert, inkl. Abschlussprofil KP 314-1
Aluminium silver anodised, incl. edge cover KP 314-1

H (mm)	H panel (mm)	Art.-Nr.:
2520	2430	MI 504
2090	2000	MI 505
1590	1500	MI 506



SPACEWALL®

Ladenbausystem

MONOSTYLE



Monostyle
Monostyle

Steckbuchse

Socket

bestehend aus: *set consisting of:*
 1 Buchse (konkav) ¹⁾ 35 x 35 mm, *1 Socket (konkav) ¹⁾ 35 x 35 mm*
 1 Sechskantmutter ²⁾, *1 Hexagon nut²⁾,*
 1 Unterlegscheibe ³⁾ *1 Grommet ³⁾*

Bohrung Buchse 16mm (für 19 mm Platten geeignet)
Drilling of Socket 16 mm (available for 19 mm walls)

Passende Kunststoffringe für Glas ⁴⁾ (Glasbohrung 22 mm Durchmesser)
 müssen separat bestellt werden.

Valid rubber rings for glass (Drilling diameter 22 mm) are not included in the set and have to be ordered seperately.



Ausführung	Art.-Nr.:
Alu-blank <i>alu-blank</i>	LM 600-1
Alu-mattverchromt <i>Alu-dull chromed</i>	LM 600-2
Alu-mattvernickelt <i>Alu-dull nickeled</i>	LM 600-3
Kunststoffringe <i>rubber rings</i>	LM 600-5

Dübelbuchse

Screw Anchor Socket

bestehend aus: *set consisting of:*
 1 Dübelbuchse, 35 x 35 x 95 mm, *1 Screw Anchor Socket 35 x 35 x 95 mm*
 1 Dübel (S20), *1 Screw Anchor,*

Zum Einbau in Ziegel- oder Betonmauerwerk
For installation into brick or concrete masonry



Ausführung	Art.-Nr.:
Alu-blank <i>alu-blank</i>	LM 620-1
mattverchromt <i>dull chromed</i>	LM 620-2
mattvernickelt <i>dull nickeled</i>	LM 620-3

Glasplattenhalter

Glass Shelf Bracket

28
mm

für 8 mm Glasplatten, paarweise zu verwenden,
 Tragkraft 8 kg

for 8 mm glass plates, to be used in pairs, load capacity 8 kg

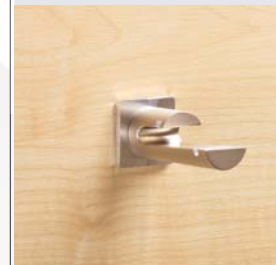

Ausführung	Art.-Nr.:
Alu-blank <i>alu-blank</i>	LM 609-1
Alu-mattverchromt <i>Alu-dull chromed</i>	LM 609-2
Alu-mattvernickelt <i>Alu-dull nickeled</i>	LM 609-3

Schraubbuchse

Screw Socket

für nachträglichen Einbau in Holzplattenwerkstoffe
 ab 19 mm Dicke, Bohrung Ø 15 mm, 35 x 35 x 47 mm
*for subsequent installation in wood panel materials
 from 19 mm thickness, drilling Ø 15 mm, 35 x 35 x 47 mm*



Ausführung	Art.-Nr.:
Alu-blank <i>alu-blank</i>	LM 621-1
mattverchromt <i>dull chromed</i>	LM 621-2
mattvernickelt <i>dull nickeled</i>	LM 621-3

Montageschlüssel

Ball holder



Zur Montage von
 Dübelbuchsen und Schraubbuchsen
 For mounting of screw anchor sockets
 and srew sockets

Art.-Nr.:
LM 624

Abhängearm
Straight Arm



gerade, mit Scheibe Ø 25 mm,
Tragkraft 18 kg

straight, with disc Ø 25 mm,
load capacity 18 kg

B (mm)	Ausführung	Art.-Nr.:
160	Edelstahl stainless steel	LM 602-1
250	Edelstahl stainless steel	LM 602-2
160	mattverchromt dull chromed	LM 602-3
250	mattverchromt dull chromed	LM 602-4

Abhängearm
Straight Arm



gerade, mit Stift Ø 6 mm,
Tragkraft 18 kg

straight, with disc Ø 25 mm,
load capacity 18 kg

B (mm)	Ausführung	Art.-Nr.:
250	Edelstahl stainless steel	LM 603-1
250	mattverchromt dull chromed	LM 603-2

Glasplattenhalter
Wood Shelf Bracket



mit Gummiringen,
with rubber bands

Tragkraft bei einer Länge von:
load capacity with a length of:
260 mm - 18 kg
310 mm - 17 kg
360 mm - 14 kg

B (mm)	Ausführung	Art.-Nr.:
260	Edelstahl stainless steel	LM 604-1
310	Edelstahl stainless steel	LM 604-2
360	Edelstahl stainless steel	LM 604-3
260	mattverchromt dull chromed	LM 604-4
310	mattverchromt dull chromed	LM 604-5
360	mattverchromt dull chromed	LM 604-6

Holzbodenträger
Wood Shelf Bracket



mit Bohrungen Ø 4,5 mm,
with drilling holes Ø 4,5 mm

Tragkraft bei einer Länge von:
load capacity with a length of:
260 mm - 18 kg
310 mm - 17 kg
360 mm - 14 kg

B (mm)	Ausführung	Art.-Nr.:
260	Edelstahl stainless steel	LM 605-1
310	Edelstahl stainless steel	LM 605-2
360	Edelstahl stainless steel	LM 605-3
260	mattverchromt dull chromed	LM 605-4
310	mattverchromt dull chromed	LM 605-5
360	mattverchromt dull chromed	LM 605-6

Glasplattenhalter mit Gewindebohrung M8
Wood Shelf Bracket with tapped hole M8



mit Gummiringen,
zur Verwendung mit Tragegange LM
610-1 bis 610-6
with rubber bands, for use with slop-
ing arm LM 610-1 to 610-6

Tragkraft bei einer Länge von:
load capacity with a length of:
260 mm - 18 kg
310 mm - 17 kg
360 mm - 14 kg

B (mm)	Ausführung	Art.-Nr.:
260	Edelstahl stainless steel	LM 604-11
310	Edelstahl stainless steel	LM 604-12
360	Edelstahl stainless steel	LM 604-13
260	mattverchromt dull chromed	LM 604-14
310	mattverchromt dull chromed	LM 604-15
360	mattverchromt dull chromed	LM 604-16

Holzbodenträger mit Gewindebohrung M8
Wood Shelf Bracket with tapped hole M8



mit Bohrungen Ø 4,5 mm,
zur Verwendung mit Tragegange LM
610-1 bis 610-6
with drilling holes Ø 4,5 mm, for use
with sloping arm LM 610-1 to 610-6

Tragkraft bei einer Länge von:
load capacity with a length of:
260 mm - 18 kg
310 mm - 17 kg
360 mm - 14 kg

B (mm)	Ausführung	Art.-Nr.:
260	Edelstahl stainless steel	LM 605-11
310	Edelstahl stainless steel	LM 605-12
360	Edelstahl stainless steel	LM 605-13
260	mattverchromt dull chromed	LM 605-14
310	mattverchromt dull chromed	LM 605-15
360	mattverchromt dull chromed	LM 605-16

Abhängearm

Straight Arm



Neigung ca. 25°, mit Kugeln
Tragkraft 18 kg

*Slope approx. 25°, with balls,
load capacity 18 kg*

B (mm)	Ausführung	Art.-Nr.:
380	Edelstahl stainless steel	LM 606-1
380	mattverchromt dull chromed	LM 606-2

Abhängearm

Straight Arm



gebogen, ca 25°, mit Kugeln
Tragkraft 18 kg

*Slope approx. 25°, with balls,
load capacity 18 kg*

Ausführung	Art.-Nr.:
Edelstahl stainless steel	LM 625-1
mattverchromt dull chromed	LM 625-2

Konsole

Console



Blech, Farbe RAL 6006
(Halter in mattchrom), gerade

*Blank sheet, colour: RAL 6006,
holder dull chromed, straight*

B x T (mm)	Art.-Nr.:
300 x 115	LM 636-1

Ballhalter

Ball Holder



Ring innen Ø150 mm,
für Ballgrößen Ø 160 - 340 mm

*Inner diameter Ø150 mm,
For ball sizes from Ø 160 - 340 mm*

Art.-Nr.:
LM 612-0

Tragestange

Bar

bestehend aus : 1 Tragestange ¹⁾, 2 Ringhalter zur Befestigung an ²⁾ Glas- oder Holzbodenträgern ³⁾, LM 604-11 bis 16 oder LM 605-11 bis 16 müssen separat bestellt werden (Gewindebohrung erfolgt ohne Aufpreis). Tragkraft 32 kg

consisting of : 1 bar ¹⁾, 2 ring holders for fixing at ²⁾ glass-/wood shelf brackets ³⁾, LM 604-11 to 16 or LM 605-11 to 16 have to be ordered separately. (Drilling is without surcharge). load capacity: 32 kg

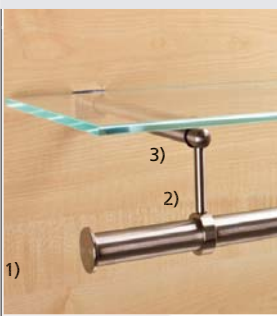

B (mm)	Ausführung	Art.-Nr.:
625	Edelstahl stainless steel	LM 610-1
1000	Edelstahl stainless steel	LM 610-2
1250	Edelstahl stainless steel	LM 610-3
625	mattverchromt dull chromed	LM 610-4
1000	mattverchromt dull chromed	LM 610-5
1250	mattverchromt dull chromed	LM 610-6



SPACEWALL®

L a d e n b a u s y s t e m

Ministyle

Ministyle

MINISTYLE

Steckbuchse „Mini“

Socket

zum Einkleben mit Bund (Bohrung Buchse Ø 12 mm)
Länge 21 mm
for flush mounting (drilling of socket Ø 12 mm)
length: 21 mm



Ausführung	Art.-Nr.:
Alu-blank alu-blank	LM 671-1
mattverchromt dull chromed	LM 671-2
mattvernickelt dull nickeled	LM 671-3

Steckbuchse „Mini“

Socket

bestehend aus:
1 Buchse 22 x 22 mm,
1 Flachmutter
(Bohrung Buchse Ø 12 mm)

passende Kunststoffringe für Glas
(müssen separat bestellt werden)

consisting of:
1 socket 22 x 22 mm,
1 thin nut
(drilling of socket Ø 12 mm)

suitable plastic rings
(to be ordered separately)



Ausführung	Art.-Nr.:
Alu-blank alu-blank	LM 670-1
mattverchromt dull chromed	LM 670-2
mattvernickelt dull nickeled	LM 670-3
Kunststoffringe für Glasbohrung Ø 14 mm Plastic rings für glass drilling Ø 14 mm	LM 670-5

Dübelbuchse „Mini“

Screw Anchor Socket

bestehend aus:
1 Dübelbuchse 22 x 22 x 70 mm,
1 Dübel (S14)

Zum Einbau in Ziegel- oder Betonmauerwerk
For installation into brick or concrete masonry

consisting of:
1 socket 22 x 22 x 70 mm,
1 screw anchor (S14)



Ausführung	Art.-Nr.:
Alu-blank alu-blank	LM 673-1
mattverchromt dull chromed	LM 673-2
mattvernickelt dull nickeled	LM 673-3

Steckbuchse „Mini“

Socket



zum Einkleben (bündig)
for flush mounting

Art.-Nr.:
LM 672

Abhängearm

straight Arm

8
mm



mit Aufkantung, ca 20°
with upturn, approx. 20°

Tragkraft ca. 3,5 kg / *2,5 kg
load capacity approx. 3,5 kg / *2,5 kg

B (mm)	Ausführung	Art.-Nr.:
100	Edelstahl stainless steel	LM 679-1
200	Edelstahl stainless steel	LM 679-2
300*	Edelstahl stainless steel	LM 679-3
100	mattverchromt dull chromed	LM 679-4
200	mattverchromt dull chromed	LM 679-5
300*	mattverchromt dull chromed	LM 679-6

Abhängearm

straight Arm

8
mm



gerade, mit Stift,
straight, with pin

Tragkraft ca. 3,5 kg / *2,5 kg
load capacity approx. 3,5 kg / *2,5 kg

B (mm)	Ausführung	Art.-Nr.:
100	Edelstahl stainless steel	LM 676-1
200	Edelstahl stainless steel	LM 676-2
300*	Edelstahl stainless steel	LM 676-3
100	mattverchromt dull chromed	LM 676-4
200	mattverchromt dull chromed	LM 676-5
300*	mattverchromt dull chromed	LM 676-6

Tragarm

Bracket

8
mm



für Glas-/Holzböden
for glass/wood shelf brackets

Tragkraft ca. 3,5 kg / *2,5 kg
load capacity approx. 3,5 kg / *2,5 kg

B (mm)	Ausführung	Art.-Nr.:
150	Edelstahl stainless steel	LM 677-1
250*	Edelstahl stainless steel	LM 677-2
150	mattverchromt dull chromed	LM 677-3
250*	mattverchromt dull chromed	LM 677-4

Schrägabhänger

Arm

8
mm



mit 7 Stiften
with 7 pins

Tragkraft ca. 2,5 kg
load capacity approx. 2,5 kg

B (mm)	Ausführung	Art.-Nr.:
290	Edelstahl stainless steel	LM 678-1
290	mattverchromt dull chromed	LM 678-2

SPACEWALL®
Ladenbausystem

Microstyle
Microstyle

MICROSTYLE

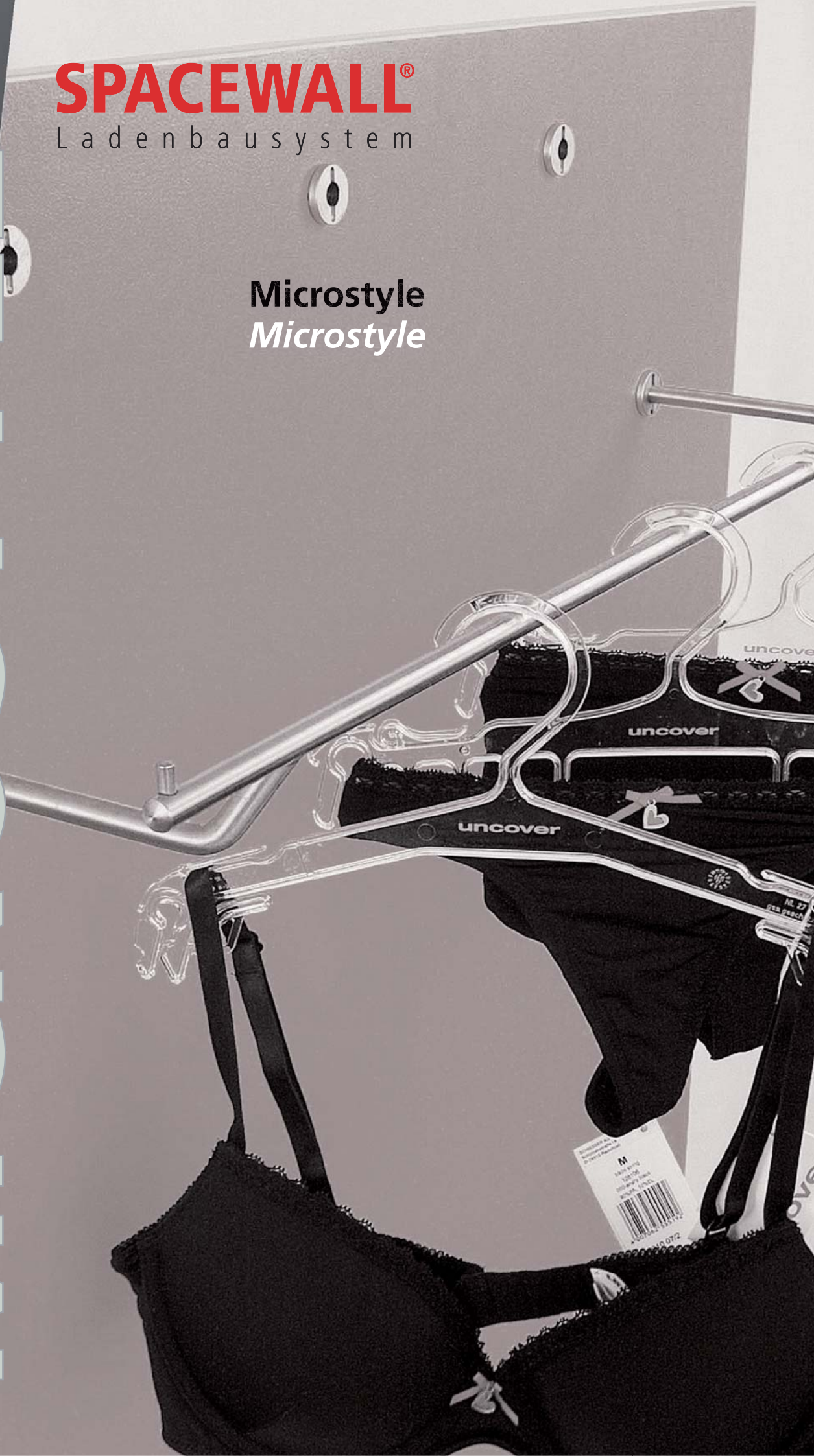

Einpressbuchse „Micro“

Socket



zum Einkleben, mattvernickelt, Länge 21 mm, für Platten ab 19 mm Stärke, Tragkraft ca. 4 kg
for flush mounting, dull-nickeled, length: 21 mm, for walls from 19 mm thickness, load capacity: 4 kg

Art.-Nr.:
LM 660-1

Glas-/Holzbodenträger

Glass / Wood Shelf Bracket



mit Bohrung zur Befestigung von Holzböden, mit Gummiringen, Tragkraft ca. 4 kg
with drilling for fixing of wood shelf brackets, with rubber rings, load capacity approx. : 4 kg

L (mm) Art.-Nr.:
 200 **LM 661-1**

Einzel-Glaspräsentier

Single Glass Socket



für Glasböden Stärke 6-8 mm Größe ca. 125 x 300 mm mattvernickelt, Tragkraft ca. 2,5 kg
for glass brackets, thickness from 6-8 mm, size: 125 x 300 mm, load capacity approx. : 2,5 kg

Art.-Nr.:
LM 663-0

Konfektionsstange

Bar



für Buchsenabstand 625 mm, Tiefe 200 mm, Tragkraft ca. 8 kg
for socket diameter of 625 mm, depth 200 mm, load capacity approx. : 8 kg

L (mm) Art.-Nr.:
 750 **LM 662-0**

T-Arm

T Bar



gerade, mit Stiften, Tragkraft ca. 3,5 kg
straight, with pins, load capacity approx.: 3,5 kg

L x B (mm) Art.-Nr.:
 200 x 350 **LM 662-5**

Abhängearm

Straight Arm



gerade, mit Stift
 Tragkraft ca. 4 kg
straight, with pin load capacity: 4 kg

L (mm) Art.-Nr.:
 100 **LM 660-5**
 160 **LM 660-6**
 200 **LM 660-7**
 260 **LM 660-8**
 310 **LM 660-9**

Brillenpräsentier (Set)

Eyeglass Holder



inkl. Alu-Einpressbuchse Ø 9,5 mm, Bohrung Ø 8 mm, für Platten ab 13 mm Stärke, Lochtiefe 14,5 mm. **ACHTUNG: Brillenhalter nicht mit MICROSTYLE-Buchse einsetzbar!**

including alu socket Ø 9,5 mm, drilling Ø 8 mm, for walls of 13 mm thickness, borehole 14,5 mm. Attention! Eyeglass holder is not compatible with MICROSTYLE socket.

Art.-Nr.:
LM 650

SPACEWALL®

Ladenbausystem



ECOSTYLE
Ecostyle

ECOSTYLE

Schlitzrohrprofil

Slot Pipe



natur E 6 / EV 1 eloxiert
für 19 mm Plattenstärke
Lochung 25 x 4 mm

*natural E 6 / EV 1 anodised for 19 mm
walls, boring 25 x 4 mm*

L (mm)	Art.-Nr.:
2500	LE 800-1
3000	LE 800-2

Doppel - Schlitzrohrprofil

Twin Slot Pipe



natur E 6 / EV 1 eloxiert
für 19 mm Plattenstärke
Lochung 25 x 4 mm

*natural E 6 / EV 1 anodised for 19 mm
walls, boring 25 x 4 mm*

L (mm)	Art.-Nr.:
2500	LE 800-3
3000	LE 800-4

Tragegange

Bar



Ovalrohr 30 x 15 mm
Oval tube 30 x 15

L (mm)	Art.-Nr.:
1000	LE 801-1

Aufsteckarm

Mounting Arm



i.V.m. Tragegange
LE 817 / 801-1

*for combination with
bar LE 817 / 801-1*

L (mm)	Löcher	Art.-Nr.:
245	6	LE 818-1
430	12	LE 818-2

Tragegange

Bar



Ovalrohr 30 x 15 mm
Oval tube 30 x 15

L (mm)	Art.-Nr.:
1000	LE 817

Aufsteckarm

Mounting Arm



gerade, mit Scheibe,
i.V.m. Tragegange
LE 817 / 801-1

*straight, with disc, for combination
with bar LE 817 / 801-1*

L (mm)	Art.-Nr.:
300	LE 822-1

Einzelhaken

Single Hook



i.V.m. Tragegange
LE 817 / 801-1

*for combination with
bar LE 817 / 801-1*

L (mm)	Art.-Nr.:
150	LE 802-1
250	LE 802-2

Aufsteckarm

Mounting Arm



vorgeneigt,
i.V.m. Tragegange
LE 817 / 801-1, mit 10 Kugeln

*slanted, for combination with
bar LE 817 / 801-1, with 10 balls*

L (mm)	Art.-Nr.:
300	LE 821-1

Z-Abhängearm

Z Sloping Arm



i.V.m. Tragegange
LE 817 / 801-1

*for combination with
bar LE 817 / 801-1*

L (mm)	Art.-Nr.:
400	LE 819

Aufsteckarm

Mounting Arm



vorgeneigt,
i.V.m. Tragegange
LE 817 / 801-1

*slanted, for combination with
bar LE 817 / 801-1*

L (mm)	Ausführung	Art.-Nr.:
480	12 Stifte	LE 820-1
260	6 Stifte	LE 820-2

Regalkonsole

Console



verchromt, gerade, mit 2
Bohrlöchern (paarweise)

*chromed, straight, with 2 drill holes
(pair)*

L (mm)	Art.-Nr.:
180	LE 816-0
280	LE 816-2
380	LE 816-3

Frontalpräsenler

Frontal Arm



mit 5 Kugeln
i.V.m. Tragegestange
LE 817 / 801-1

*with 5 balls, for mounting and
combination with bar LE 817 / 801-1*

L (mm)	Art.-Nr.:
170	LE 826

Abhängestange

Sloping Arm



Ovalrohr 25 x 12 mm

Oval tube 25 x 12

L (mm)	Ausführung	Art.-Nr.:
1000	"Modern Art"	LE 823
1000	Gebogen <i>curved</i>	LE 823-1

Frontalpräsenler

Frontal Arm



mit 10 Kugeln
i.V.m. Tragegestange
LE 817 / 801-1

*with 10 balls, for mounting and
combination with bar LE 817 / 801-1*

L (mm)	Art.-Nr.:
330	LE 827-1

Einzelhaken

Single Hook



mit Aufkantung,
i.V.m. Tragegestange
LE 817 / 801-1

*with lip, for combination with
bar LE 817 / 801-1*

L (mm)	Art.-Nr.:
100	LE 824-1
200	LE 824-3
300	LE 824-5

Glasplattenhalter

Glass Shelf Bracket



für 8 mm Glasplattenstärke
und max 300 mm -tiefe
(paarweise)

*for glass shelves with 8 mm thickness
and max. depth of 300 mm*

L (mm)	Art.-Nr.:
110	LE 829

S-Abhängearm

S Sloping Arm



zum Aufstecken
i.V.m. Tragegestange
LE 817 / 801-1

*for mounting and combination with
bar LE 817 / 801-1*

L (mm)	Art.-Nr.:
300	LE 825



Index nach Artikelnummern / Index by Item Numbers

Art.-Nr.	Seite / Page	Art.-Nr.	Seite / Page	Art.-Nr.	Seite / Page	
Sonderprogramm / Special Accessories		PF 198	26	TW 454-0, TW 454-1, TW 454-2	11	
G 101, G 102, G 103, G 104, G 105	20	PF 199	26	TW 455	16	
G 106, G 107, G 108, G 109, G 110	20	PF 200	26	TW 455-2	17	
G 111, G 112, G 113, G 122	20	Metal-Warenträger TW / Metal Access. TW			TW 456-1, TW 456-2	13
Warenträger MF / Accessories MF		TW 400-1, TW 400-2, TW 400-3, TW 400-4, TW 400-5	11	TW 458, TW 459	17	
MF 265-1, MF 265-2, MF 265-7, MF 265-8	8	TW 401-1, TW 401-2, TW 401-3, TW 401-4, TW 401-5, TW 401-6, TW 401-7, TW 401-8	10	TW 460-1, TW 460-2	17	
MF 265-3, MF 265-4, MF 265-9, MF 265-10	8	TW 402-1, TW 402-2, TW 402-3	14	TW 461-1, TW 461-2	17	
MF 265-11, MF 265-12, MF 265-13, MF 265-14	8	TW 403	14	TW 462-1, TW 462-2	17	
MF 265-15, MF 265-16	8	TW 404	12	TW 463	13	
MF 278	8	TW 405	12	TW 464	10	
MF 2.80-1, MF 2.80-2, MF 2.81, MF 2.82, MF 2.83	9	TW 406	12	TW 465	17	
Warenträger PF /		TW 407	15	TW 469-1, TW 469-2	13	
Plastics Accessories PF		TW 407-1	15	TW 470	13	
PF 101-0, PF 101-1, PF 101-2, PF 101-4, PF 101-5, PF 101-6	22	TW 407-2	15	TW 471	17	
PF 102, PF 103	22	TW 407-3	15	TW 472-0, TW 472-1, TW 472-2, TW 472-3, TW 472-4, TW 472-5	14	
PF 105	22	TW 408	15	TW 473-0, TW 473-1, TW 473-2, TW 473-3, TW 473-4	10	
PF 106, PF 107	22	TW 409-0, TW 409-1, TW 409-2, TW 409-3, TW 409-4	14	TW 474	15	
PF 110, PF 111	22	TW 410-1, TW 410-2	14	TW 477-2, TW 477-3, TW 477-4, TW 477-5	10	
PF 112-1	22	TW 4100-1, TW 4100-2, TW 4100-3, TW 4100-4, TW 4100-5	10	TW 478-2, TW 478-3, TW 478-4	11	
PF 113-1, PF 113-2, PF 113-3	22	TW 4101-1, TW 4101-2, TW 4101-3, TW 4101-4, TW 4101-5	11	TW 479-1, TW 479-2, TW 479-3, TW 479-4, TW 479-5	10	
PF 114-1, PF 114-2	22	TW 4107-2	15	TW 480	17	
PF 114-3, PF 114-4	22	TW 411-1, TW 411-2, TW 411-3, TW 411-4, TW 411-5, TW 411-6	10	TW 481-1, TW 481-2	13	
PF 115	22	TW 413	15	TW 482	17	
PF 117-0, PF 117-1	23	TW 414-2, TW 414-3, TW 414-4, TW 414-5	10	TW 483	13	
PF 117-2, PF 117-3	23	TW 416	15	TW 484	17	
PF 118	23	TW 417	15	Kunststoff-Warentr. TW / Plastics Access. TW		
PF 120-1	23	TW 418	15	TW 191-L, TW 191-R	27	
PF 121-0, PF 121-1, PF 121-2, PF 121-4, PF 121-5	23	TW 4175-1, TW 4175-2, TW 4175-3, TW 4175-4	11	TW 476-1, TW 476-2, TW 476-3	11	
PF 122	23	TW 422	16	TW 476-5	11	
PF 124	23	TW 423	16	TW 485-1, TW 485-2	26	
PF 141	23	TW 424-0, TW 424-1, TW 424-2, TW 424-3, TW 424-4	14	TW 486	26	
PF 142	23	TW 425	16	TW 487	26	
PF 145	24	TW 426	16	TW 488, TW 488-1	26	
PF 146	24	TW 427	16	TW 489-1	26	
PF 149	24	TW 428	16	TW 489-3	26	
PF 155	24	TW 430-3, TW 430-4, TW 430-5	14	TW 489-2	27	
PF 157	24	TW 438	16	TW 491	27	
PF 158	24	TW 439	16	TW 493	27	
PF 159	24	TW 441-1	12	TW 494	27	
PF 161-1, PF 161-2, PF 161-3, PF 161-4	24	TW 442	12	TW 495	27	
PF 162-1, PF 162-2, PF 162-3, PF 162-4	24	TW 443-0, TW 443, TW 443-1	14	TW 496	27	
PF 166	24	TW 443-5	14	TW 497-1, TW 497-2	27	
PF 167	25	TW 444	14	TW 498-1, TW 498-2	27	
PF 168-1, PF 168-2	25	TW 4443-0, TW 4443-1, TW 4443-2, TW 4443-3	14	TW 499-0, TW 499-1, TW 499-2, TW 499-3	11	
PF 176-2, PF 176-3	25	TW 445	12	Seidenmatt verchromt TW / Satin Chrome TW		
PF 181-1	25	TW 447	12	TW 500-1, TW 500-2, TW 500-3, TW 500-4,	18	
PF 181-2	25	TW 448-1, TW 448-2	12	TW 501-1, TW 501-2, TW 501-3, TW 501-4	18	
PF 184	25	TW 449, TW 449-2, TW 449-3	16	TW 504	18	
PF 185	25	TW 450, TW 450-1	12	TW 506	18	
PF 186	25	TW 451-1, TW 451-2	12	TW 507-2	18	
PF 195	25	TW 452	13	TW 543, TW 543-1	18	
PF 196	25	TW 453	13	TW 548-2	18	
PF 197	26			TW 550-1	18	
				TW 551-1	18	
				TW 577-5	18	

Index nach Artikelnummern / Index by Item Numbers

Art.-Nr.	Seite / Page	Art.-Nr.	Seite / Page	Art.-Nr.	Seite / Page
Warenträger SLIM / Slim Accessories		INTERLINK / Interlink		MICROSTYLE / Microstyle	
SF 714-1, SF 714-2	29	IL 900-1, IL 900-2, IL 900-3		LM 650	45
SF 715-1, SF 715-2, SF 715-3, SF 715-4	29	IL 900-4	35	LM 660-1	45
SF 716-1, SF 716-2, SF 716-3		IL 901-1, IL 901-2, IL 901-3		LM 660-5, LM 660-6, LM 660-7, LM 660-8, LM 660-9	45
SF 716-4, SF 716-5	29	IL 901-4	35	LM 661-1	45
SF 720-1, SF 720-2, SF 720-3	29	IL 901-5, IL 901-6, IL 901-7		LM 662-0	45
SF 721	29	IL 901-8	35	LM 662-5	45
SF 722-1, SF 722-2	29	IL 901-9, IL 901-10, IL 901-11		LM 663-0	45
SF 723	29	IL 901-12	35	MINISTYLE / Ministyle	
SF 726	29	IL 902-1	35	LM 670-1, LM 670-2, LM 670-3, LM 670-5	43
SF 730-1, SF 730-2	29	IL 903	35	LM 671-1, LM 671-2, LM 671-3	43
SF 731	29	PIVOT / Pivot		LM 672	43
SF 732-1, SF 732-2, SF 732-3, SF 732-4	30	MI 501, MI 502, MI 503	37	LM 673-1, LM 673-2, LM 673-3	43
SF 733-1, SF 733-2, SF 733-3, SF 733-4	30	MI 504, MI 505, MI 506	37	LM 676-1, LM 676-2, LM 676-3, LM 676-4, LM 676-5, LM 676-6	43
SF 734-1, SF 734-2, SF 734-3, SF 734-4	30	MONOSTYLE / Monostyle		LM 677-1, LM 677-2, LM 677-3 LM 677-4	43
SF 717-1, SF 717-2	30	LM 600-1, LM 600-2, LM 600-3, LM 600-5	39	LM 678-1, LM 678-2	43
SF 718	30	LM 602-1, LM 602-2, LM 602-3		LM 679-1, LM 679-2, LM 679-3, LM 679-4, LM 679-5, LM 679-6	43
SF 741, SF 742	30	LM 602-4	40	ECOSTYLE / Ecostyle	
SF 745	30	LM 603-1, LM 603-2	40	LE 800-1, LE 800-2	47
SF 746	30	LM 604-1, LM 604-2, LM 604-3, LM 604-4, LM 604-5, LM 604-6, LM 604-11, LM 604-12, LM 604-13, LM 604-14, LM 604-15, LM 604-16	40	LE 800-3, LE 800-4	47
SF 758	30	LM 605-1, LM 605-2, LM 605-3, LM 605-4, LM 605-5, LM 605-6	40	LE 801-1	47
SF 759	30	LM 605-11, LM 605-12, LM 605-13, LM 605-14, LM 605-15, LM 605-16	40	LE 802-1, LE 802-2	47
Profile & Kleinteile / Profiles		LM 606-1, LM 606-2	41	LE 816-0, LE 816-2, LE 816-3	48
KP 301, KP 301-0, KP 301-1, KP 301-2	32	LM 609-1, LM 609-2, LM 609-3	39	LE 817	47
KP 302, KP 302-0, KP 302-1, KP 302-2	32	LM 610-1, LM 610-2, LM 610-3, LM 610-4, LM 610-5, LM 610-6	41	LE 818-1, LE 818-2	47
KP 303, KP 303-0, KP 303-1, KP 303-2	32	LM 612-0	41	LE 819	47
KP 305	32	LM 620-1, LM 620-2, LM 620-3	39	LE 820-1, LE 820-2	47
KP 308-1, KP 308-2, KP 308-3	33	LM 621-1, LM 621-2, LM 621-3	39	LE 821-1	47
KP 310	32	LM 624	39	LE 822-1	47
KP 314, KP 314-0, KP 314-1, KP 314-2	32	LM 625-1, LM 625-2	41	LE 823, LE 823-1	48
KP 315-1	33	LM 636-1	41	LE 824-1, LE 824-3, LE 824-5	48
KP 316	33			LE 825	48
KP 320, KP 320-0, KP 320-1, KP 320-2	32			LE 826	48
KP 330-1				LE 827-1	48
KP 331	32			LE 829	48
KP 332	33				

ONLINE-SHOP

Bestellen Sie bequem online in unserem Onlineshop unter

www.reinhardt-ladenbau.de